









FITMENT INSTRUCTIONS



VW AMAROK DOUBLE CAB

XTREME, XPEDITION & RHINOLITE

FITMENT KIT CONTENTS

DESCRIPTION	QUANTITY	ILLUSTRATION
• M8 x 25 Bolt	16	
• M8 x 30 Bolt	12	
• M8 Nylock Nut	8	
• M8 Flat Washer	28	
• Cab Side Bracket Inner	2	
• Cab Side Bracket Outer	2	
• Tail Gate Bracket Inner	2	
• Tail Gate Bracket Outer	2	

REQUIRED TOOLS

DESCRIPTION	ILLUSTRATION
• 13mm Spanner	
• 13mm Socket Wrench (Optional)	

INSTALLATION TIME & CARE INSTRUCTIONS

Approx. 45 Minutes (Excluding the removal of any accessories from load bin)

- ✓ Before installation, ensure that your hands and workwear are clean from oil, grime & dirt.
- ✓ Ensure that the correct tools and PPE are used whilst installing the canopy. Clean the rear cab window before fitting the canopy.
- ✓ Torque all M8 fasteners to approx. 28Nm.

FITMENT STEPS

STEP 1

- ✓ Unpack all components and hardware from packaging: ensure that everything is accounted for as indicated above.

STEP 2

- ✓ Remove any cab guards, roll bar, tonneau cover, sports bar etc. from vehicle.

STEP 3

- ✓ Remove the factory fitted tie-down hooks.
- ✓ Insert the provided cab side and tail gate side brackets. (Image below)
- ✓ Secure brackets with provided bolts on the OEM tie-down points.
- ✓ Ensure that the rear cab window of the vehicle is clean, before loading the canopy onto the load bin.

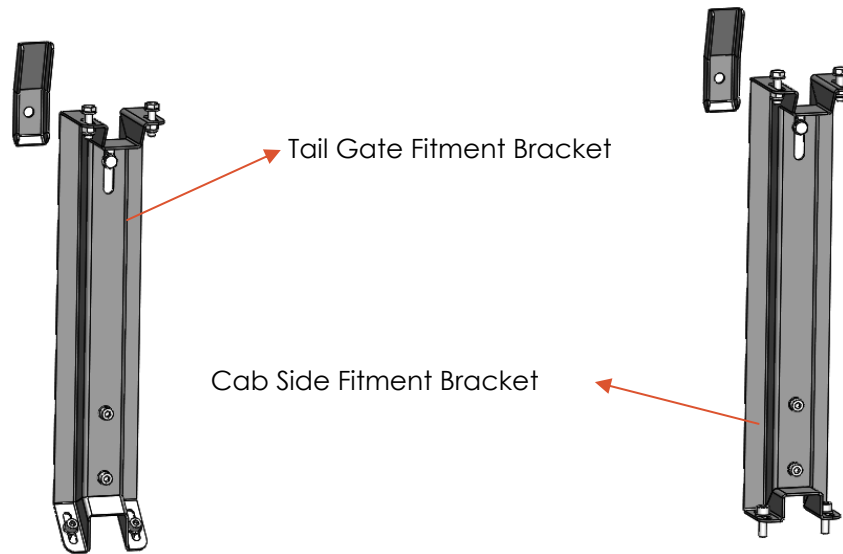

STEP 4

- ✓ Fit the canopy to the loading bin, align & space evenly.
- ✓ Identify the front & rear tie-down points in the load bin, as these points will be used for the fitment brackets. Refer to "FIG 1." For tie-down positions.
- ✓ Fit both tail gate & cab side fitment brackets in position. Do not over tighten as you might need to adjust bracket heights. Below illustration applicable to both tail-gate & cab side fitment brackets.

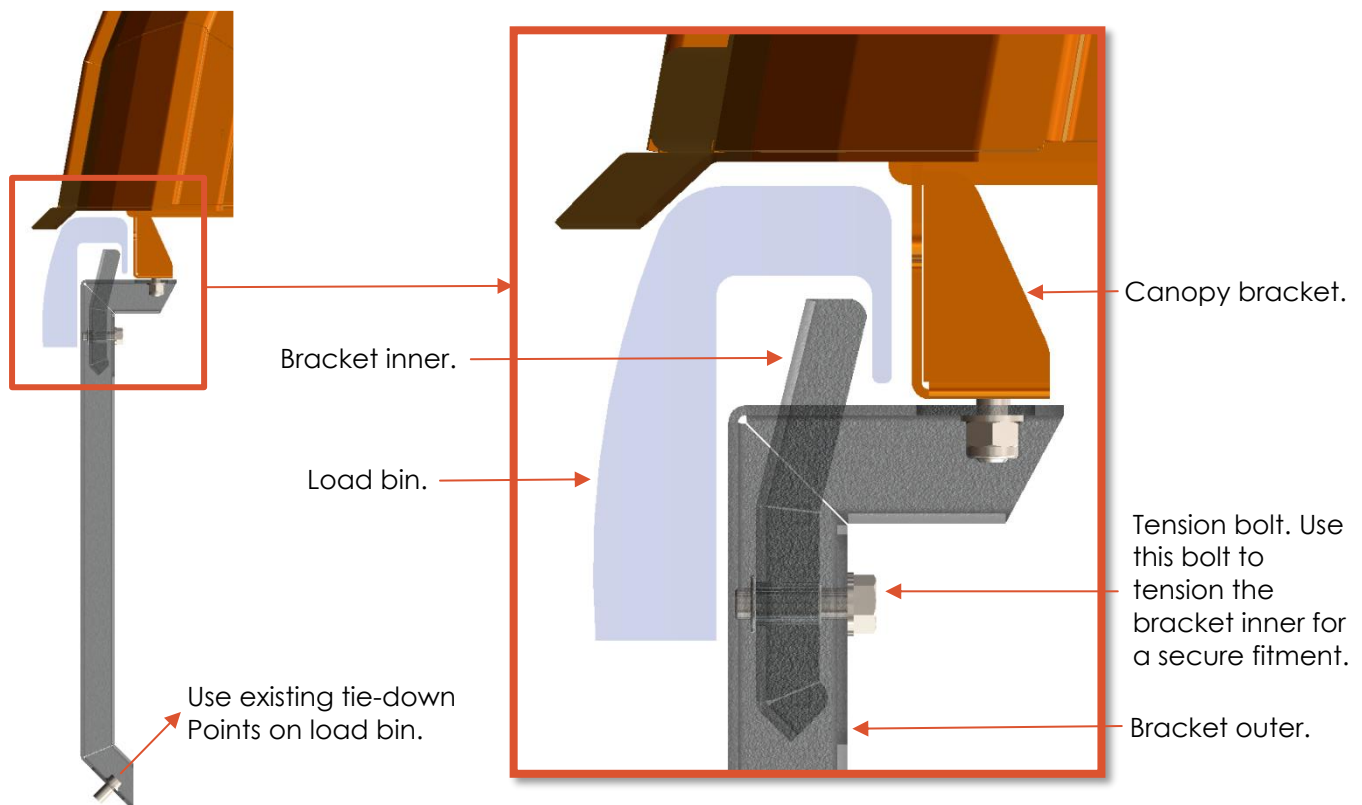

- ✓ Align the canopy fastening points with the brackets' fastening points. (Fig. 1).
- ✓ When the canopy is resting on the load bin, adjust the brackets to achieve a gap of approx. 6mm between the canopy fastening surface and the bracket top surface. (Fig2.)
- ✓ Secure the brackets to the load body by fastening the bolts slowly & securely.
- ✓ Secure the canopy to the brackets using the bolts supplied, tighten the bolts to secure the two surfaces firmly, into the factory supplied threaded holes.

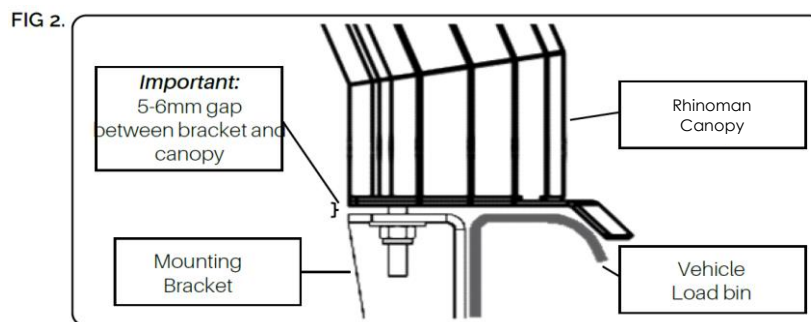
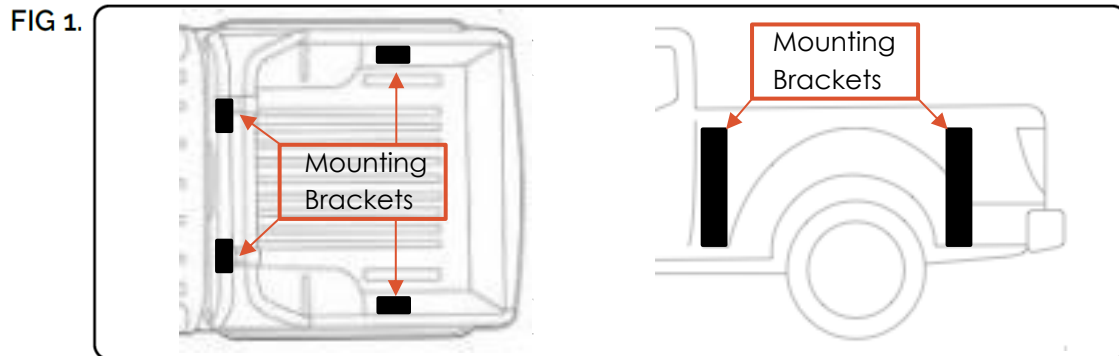

STEP 5

- ✓ Trim sealing rubber on tailgate with knife or scissors.
- ✓ Check again for alignment of canopy on sides of loading bin.
- ✓ Check all bolts one final time.
- ✓ Enjoy your NEW Rhinoman all Aluminum Canopy.

WARRANTY SERVICE & CARE GUIDE

- ✓ All Rhinoman products carry a comprehensive 2-year factory warranty on the Aluminum welded frame, and a 1-year warranty on all mechanical components.
- ✓ **PLEASE NOTE:** Your canopy will only be covered under warranty if it has been fitted by an approved Rhinoman fitment center or agent.
- ✓ Please do inspect the fasteners on the fitment brackets every once in a while, to ensure that all bolts are still tight and properly secured.

SHOULD YOU HAVE ANY ENQUIRIES ABOUT THE FITMENT, FEEL FREE TO CONTACT US



010 010 0060



SALES@RHINOMAN.CO.ZA



RHINOMAN.CO.ZA